

# LARA DININGBENCH

3-seater

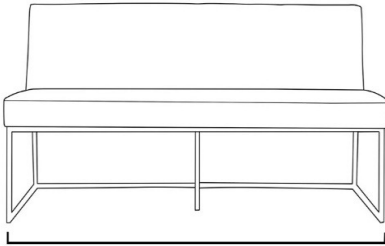

148 cm

3,5-seater

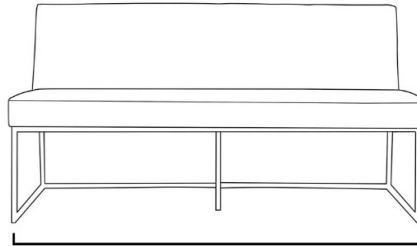

172 cm

4-seater

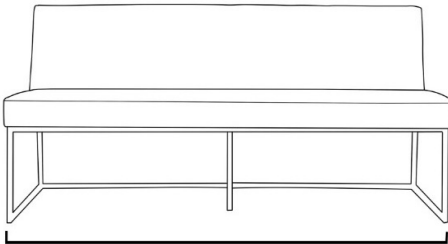

196 cm

4,5-seater

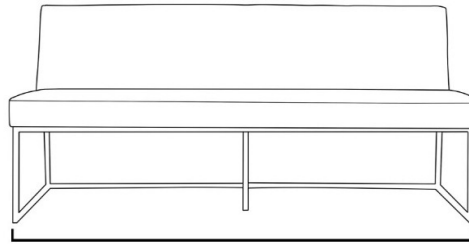

220 cm

5-seater

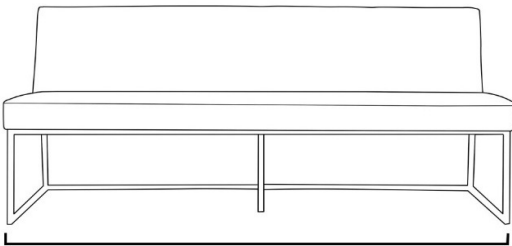

244 cm

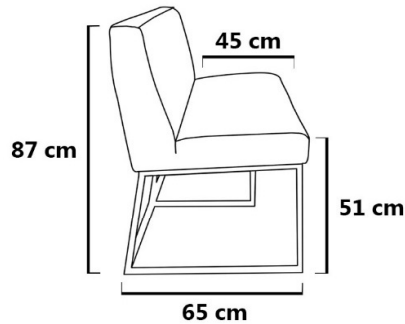

open naad /  
open seam /  
offene Naht

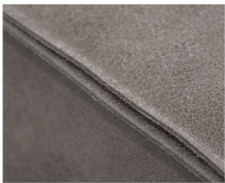

LARA/ FRED'S

geknepen naad /  
pinched seam /  
"Salsa-Naht"



ZARA

platgestikt /  
flat stitching /  
Ebene Naht

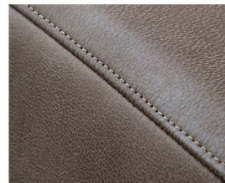

LARA/ ZARA

feston stiksel /  
feston stitching /  
feston Stich



LARA FESTON

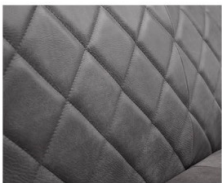

LARA STEPS



RVS-frame of mat-zwart poedercoating  
metal frame Stainless steel or powdercoating matt black  
gebürstet Edelstahl oder schwarzes Stahl (pulverbeschichtet)

Caution: Using different molds, fabric stitches may differ in fabric with the stitches of the same models in leather  
All sizes are approximate, technical and stylistic changes are reserved! Keep typing errors!

